

°LAUDA



OVERALL BROCHURE CONSTANT TEMPERATURE EQUIPMENT 2024/2025

°FAHRENHEIT. °CELSIUS. °LAUDA.

LAUDA

COOLING THERMOSTATS

°LAUDA



Specific application examples

- Sample preparation in chemistry and pharmacy
- Functional testing of electronic components
- Test of slide bearings
- Valve testing
- Stress test
- Notch bending test
- Expansion testing
- Brookfield test
- Semi-conductor coating



LAUDA Alpha

Affordable cooling thermostats for maintaining temperatures from -25 to 100 °C in the lab

-25 °C  100 °C

The cost-efficient choice for high-quality LAUDA thermostats

LAUDA Alpha offers reliable technology for temperature ranges from -25 to 100 °C. This line of devices is suitable for internal and external temperature control thermostating with non-flammable liquids (water and water/glycol). The thermostats are the perfect solution for most basic temperature control applications in the lab. Optimized down to the most essential functions, this affordable product line will win you over with its reliability and user-friendliness.

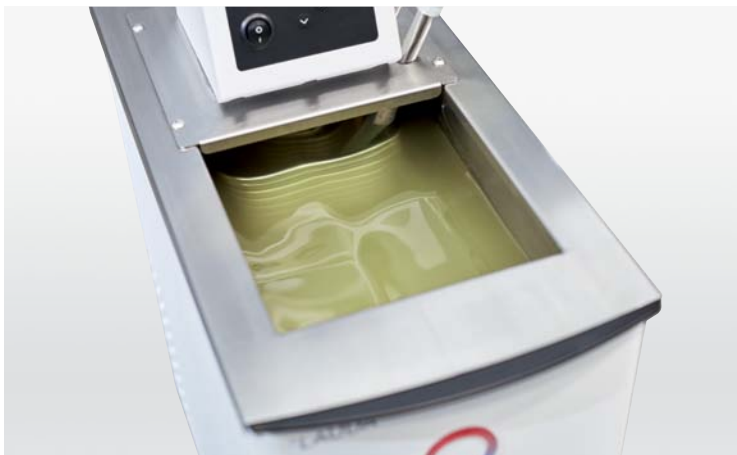

Cost savings through automatic compressor control: Cooling capacity is only provided when it is needed



Easy cleaning of the cooling air inlet enabled by simple removal of front cover without tools

COOLING PERFORMANCE Heat transfer liquid: Ethanol, bath closed

Bath temperature °C

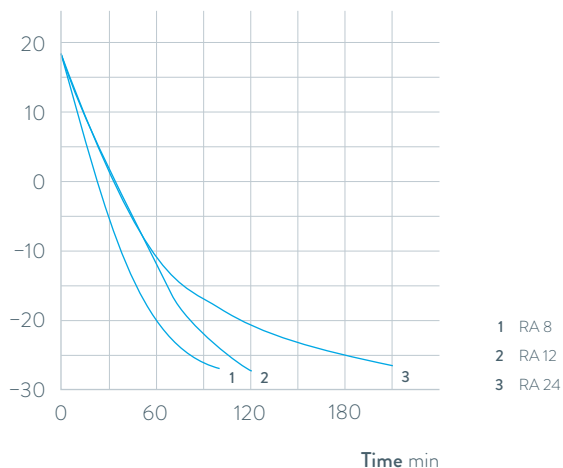

1 RA 8
2 RA 12
3 RA 24

Important functions

- Stainless steel bath vessels
- Drain connection at the rear

Included accessories

Pump circulation set, bath cover, pump link for pump connections

Further accessories

Racks, tubing

All technical data and power supply variants can be found in the ›Technical data‹ section.

More at www.lauda.de/de/1736



LAUDA Alpha

The cooling thermostats RA 8, RA 12 and RA 24, including standard-issue bath covers and pump connections, facilitate cooling across the entire temperature range from -25 to 100 °C. Automatic compressor control extends the service life of the compressor and offers savings on operation costs.



LAUDA ECO

From -50 to 200 °C: Cooling thermostats for economic temperature control in the lab



Impressive range of capabilities coupled with easy operation

The ECO thermostats are available in Silver (LCD) or Gold (color TFT display) models with a large number of interface modules as accessories. The circulation pump can be adjusted to six levels. The comprehensive model portfolio offers devices with cooling capacities of 180 to 700 watts and minimum temperatures of -15 to -50 °C. The devices of the LAUDA ECO series with the highest performance work with an energy-saving LAUDA SmartCool system, which automatically adjusts the cooling capacity to the required operating status.

The low-temperature thermostats are also available with natural refrigerants as standard for extra environmentally-friendly operation.



Plain text menu guidance on a monochrome LCD (Silver) or color TFT display (Gold) for easy and intuitive operation



Standard pump connections for temperature control of external applications

COOLING PERFORMANCE Heat transfer liquid: Ethanol, bath closed

Bath temperature °C

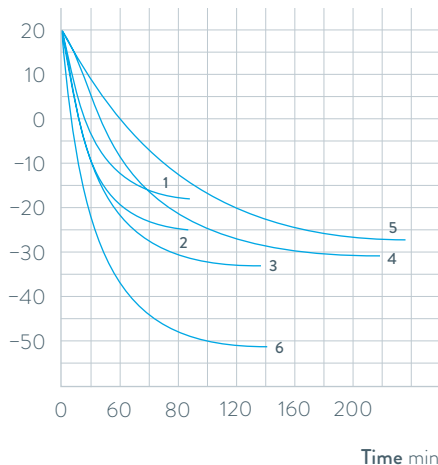

- 1 RE 415 G
- 2 RE 420 G
- 3 RE 630 G
- 4 RE 1225 G
- 5 RE 2025 G
- 6 RE 1050 G

Important functions

- Integrated programmer for automating temperature profiles
- Adjustment of flow rate switch for internal/external circulation, can be actuated from exterior during operation
- USB interface as standard

Included accessories

Bath cover, pump connections, closing plugs

Further accessories

Tubing, interface modules (P. 99)

All technical data and power supply variants can be found in the ›Technical data‹ section.

More at www.lauda.de/de/1738



LAUDA ECO

The cooling thermostats come with a bath cover and pump connections as standard. A drain tap on the back side of the device makes changing the heat transfer liquid easy and safe.



LAUDA PRO

Cooling bath thermostats for professional temperature control from -100 to 200 °C



Flexible operation, outstanding performance

With LAUDA PRO, customers gain access to a cutting-edge product line with an outstanding overall concept. There are two operating units available: Base or Command Touch. These can be removed from the thermostat for very high levels of flexibility. On the one hand, this permits remote control of the devices and on the other hand, this considerably reduces the height of the devices. In addition, they are also equipped with a hybrid cooling system as standard. This enables additional cooling of the refrigerating machine with water.



Low device height and 360° accessibility of the bath thanks to detachable remote control

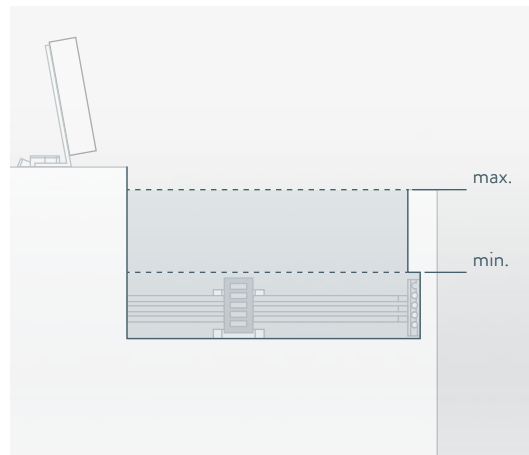

Full functionality of the bath with low minimum fill height

COOLING PERFORMANCE Heat transfer liquid: Ethanol, bath closed

Bath temperature °C

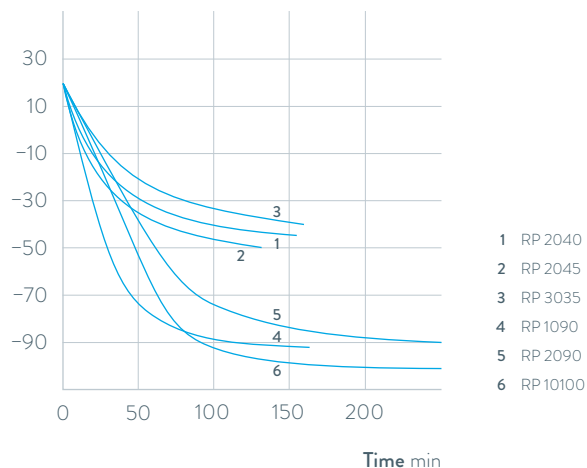

Important functions

- Internal LAUDA Vario Pump with 8 selectable output levels
- Hybrid cooling of the refrigerating machine permits cooling using ambient air or, in addition, using cooling water
- Standard bath edge heating on all types prevents the formation of ice on the surface of the bath cover
- Ethernet, USB and Pt100 as standard

Included accessories

Bath cover, tubing nipples with screw caps for the cooling coil

Further accessories

External pump, interface modules

All technical data and power supply variants can be found in the [Technical data](#) section.

More at www.lauda.de/de/1740



LAUDA PRO

The PRO cooling bath thermostats for internal bath applications offer a working temperature range from -100 to 200 °C. An incrementally adjustable pump ensures excellent homogeneity of the bath. With their bath sizes from 10 to 30 liters and cooling capacity from 0.4 to 1.5 kW, the thermostats are suitable for a wide range of applications.



LAUDA Proline Kryomats

High-performance cooling thermostats from -90 to 200°C for use in process technology and material testing

-90°C

200°C

High cooling performance and compact design

The Proline Kryomats are cooling thermostats that feature the latest technology with high efficiency and an excellent price-performance ratio. The pressure pump is optimized for internal circulation and can be set to four levels – the standard-issue LAUDA Command remote control also makes it especially user-friendly. Furthermore, integrated bath edge and bath bridge heating prevent the formation of condensation caused by air humidity at low temperatures.

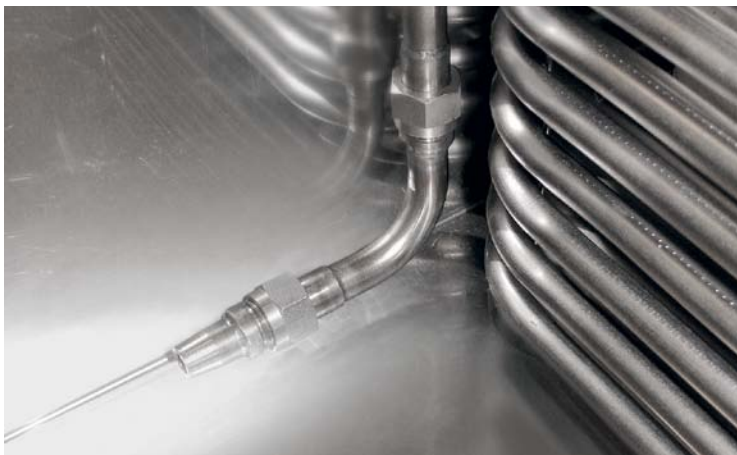

Optimal circulation and temperature distribution throughout the entire bath thanks to an adjustable pump nozzle



Spacious baths and large bath openings – ideal for bulky test specimens and effective throughput

COOLING PERFORMANCE Heat transfer liquid: Ethanol, bath closed

Bath temperature $^{\circ}\text{C}$

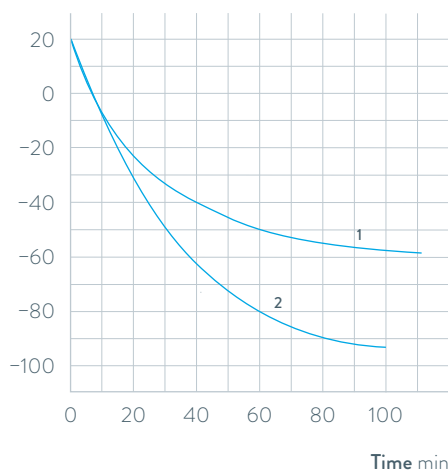

1 RP 4050 C

2 RP 4090 C

Important functions

- Removable Command operating unit with high-resolution, graphic LCD screen and individually selectable display functions
- Programmer with 150 temperature/time segments, can be divided into 5 programs
- Pump connections on side and rear, integrated bypass

Included accessories

Bath cover, tubing nipples

Further accessories

Inset baskets, interface modules

All technical data and power supply variants can be found in the »Technical data« section.

More at www.lauda.de/de/1742



LAUDA Proline Kryomats

The air and water-cooled versions of the Proline Kryomats are available with large bath openings and volumes of 30 and 40 liters.



LAUDA Cooling thermostats

Device type overview

LAUDA Alpha / Page 90

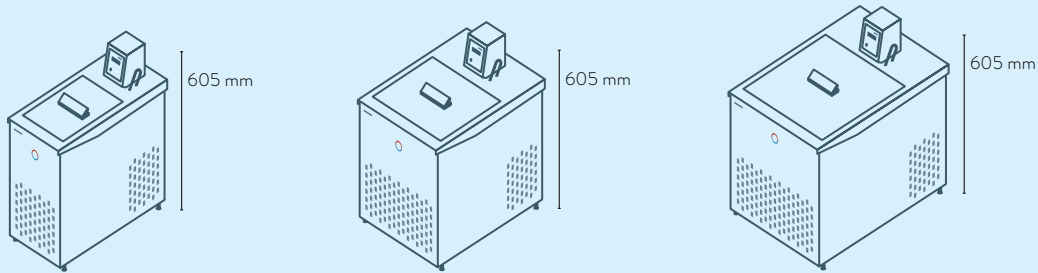

RA 8

RA 12

RA 24

LAUDA ECO / Page 92

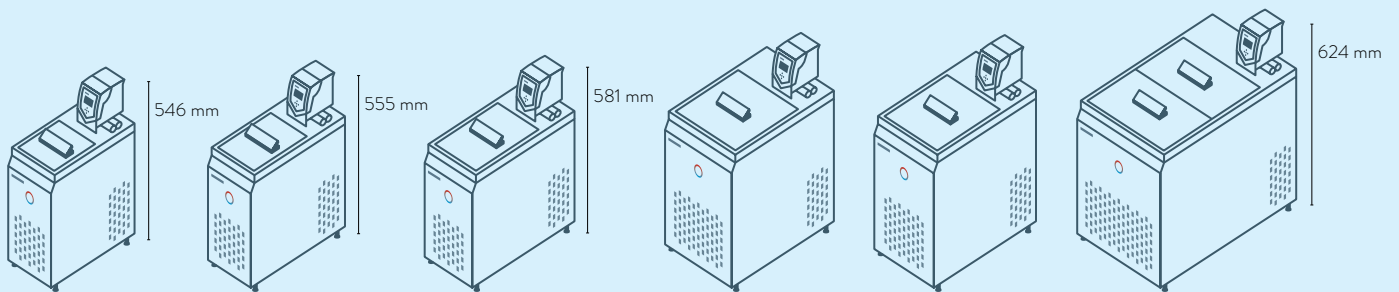

RE 415 S
RE 415 G

RE 420 S
RE 420 G

RE 630 S
RE 630 G

RE 1050 S
RE 1050 G

RE 1225 S
RE 1225 G

RE 2025 S
RE 2025 G

LAUDA PRO / Page 94

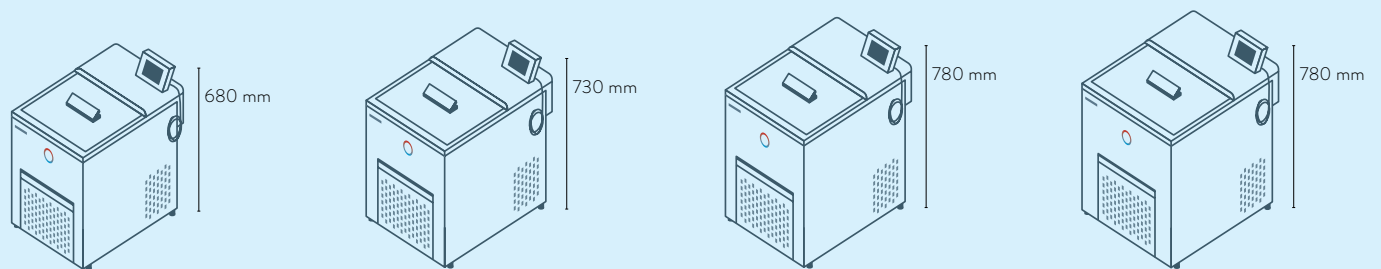

RP 2040 C
RP 2045 C

RP 3035 C

RP 1090 C

RP 2090 C
RP 10100 C

LAUDA Proline Kryomats / Page 96

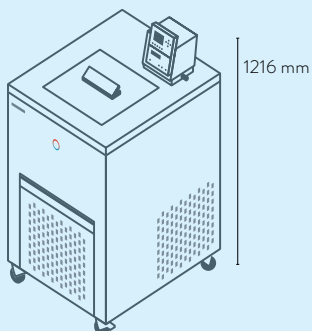

RP 4050 C / RP 4050 CW
RP 4090 C / RP 4090 CW

LAUDA Cooling thermostats

Interfaces

	Pt 100 (1)	Pt 100 (2)	USB	Ethernet	RS-232 / 485	Analog	Namur contact	D-Sub contact	PROFIBUS	EtherCAT M8	EtherCAT RJ45	Number of module slots, large	Number of module slots, small
LAUDA Alpha / Page 90	-	-	-	-	-	-	-	-	-	-	-	-	-
LAUDA ECO / Page 92	Z	-	S	Z	Z	Z	Z	Z	Z	Z	Z	1	1
LAUDA PRO / Page 94	S	-	S	S	Z	Z	Z	Z	Z	Z	Z	1	-
LAUDA Proline Kryomat / Page 96	S	-	-	Z	S	Z	Z	Z	Z	Z	Z	2	-

S = Series standard

Z = Available as an accessory



LRZ 912
Analog module



LRZ 913
RS-232/485
interface



LRZ 914
Contact module with single input
and single output (NAMUR)



LRZ 915
Contact module with
3 inputs and 3 outputs



LRZ 917
Profibus module



LRZ 918
Pt100/Li bus module,
small cover



LRZ 921
Ethernet module

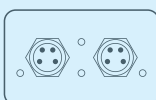

LRZ 922
EtherCAT module
with M8 connection

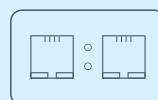

LRZ 923
EtherCAT module
with RJ45 connection



LRZ 925
External Pt100/LiBus-
module, large cover

LAUDA Cooling thermostats

Function overview

Operating element	Alpha	ECO S	ECO G	PRO Base	PRO Command Touch	Proline Kryomats
Display	7-Segment	LCD mono	TFT	OLED	TFT	LCD mono
Mode of operation	3-button	3-button softkey	Cursor softkey	Cursor softkey	Multi-touch	Cursor softkey
Removable control	-	-	-	✓	✓	✓
User management	-	-	-	-	✓	-
Data logging, export to USB stick	-	-	-	-	✓	-
1-point calibration	✓	✓	✓	✓	✓	✓
2-point calibration	-	-	-	✓	✓	-
Programmer, programs/segments	-	1 / 20	5 / 150	1 / 20	100 / 5000	5 / 150
Programmer, tolerance range function	-	✓	✓	✓	✓	✓
Ramp function	-	-	-	-	✓	✓
Timer function	-	-	-	-	✓	✓
Countdown function	✓	-	-	-	✓	✓
Graphic temperature profile display	-	-	✓	-	✓	✓
Adjustable bypass	-	-	-	-	-	✓
Level indicator (digital)	-	-	-	✓	✓	✓
Standby timer	-	✓	✓	✓	✓	✓
Low-level alarm	✓	✓	✓	✓	✓	✓
Drain tap	-	✓	✓	✓	✓	✓
Drain screw	✓	-	-	-	-	-

LAUDA Cooling thermostats

Technical data according to DIN 12876 standard

Device type	Working temperature range °C	Temperature stability ±K	Safety fittings	Heater power max. kW	Cooling output kW														Pump type	Pump pressure max. bar
					20 °C	10 °C	0 °C	-10 °C	-20 °C	-25 °C	-30 °C	-40 °C	-50 °C	-60 °C	-70 °C	-80 °C	-90 °C	-100 °C		
LAUDA Alpha / Page 90																				
RA 8	-25 ... 100	0.05	I, NFL	1.5	0.23	-	0.16	-	0.08	-	-	-	-	-	-	-	-	D	0.2	
RA 12	-25 ... 100	0.05	I, NFL	1.5	0.33	-	0.26	-	0.08	-	-	-	-	-	-	-	-	D	0.2	
RA 24	-25 ... 100	0.05	I, NFL	1.5	0.43	-	0.33	-	0.08	-	-	-	-	-	-	-	-	D	0.2	
LAUDA ECO / Page 92																				
RE 415 S	-15 ... 200	0.02	III, FL	2.0	0.18 ¹	-	0.12 ¹	-	-	-	-	-	-	-	-	-	-	V	0.55	
RE 420 S	-20 ... 200	0.02	III, FL	2.0	0.20 ¹	-	0.15 ¹	-	0.03 ¹	-	-	-	-	-	-	-	-	V	0.55	
RE 630 S	-30 ... 200	0.02	III, FL	2.0	0.30 ¹	-	0.24 ¹	-	0.10 ¹	-	0.02 ¹	-	-	-	-	-	-	V	0.55	
RE 1050 S	-50 ... 200	0.02	III, FL	2.0	0.70 ¹	-	0.60 ¹	-	0.35 ¹	-	0.19 ¹	0.10 ¹	0.02 ¹	-	-	-	-	V	0.55	
RE 1225 S	-25 ... 200	0.02	III, FL	2.0	0.30 ¹	-	0.24 ¹	-	0.09 ¹	0.04 ¹	-	-	-	-	-	-	-	V	0.55	
RE 2025 S	-25 ... 200	0.02	III, FL	2.0	0.30 ¹	-	0.23 ¹	-	0.06 ¹	0.03 ¹	-	-	-	-	-	-	-	V	0.55	
RE 415 G	-15 ... 200	0.02	III, FL	2.6	0.18 ¹	-	0.12 ¹	-	-	-	-	-	-	-	-	-	-	V	0.55	
RE 420 G	-20 ... 200	0.02	III, FL	2.6	0.20 ¹	-	0.15 ¹	-	0.03 ¹	-	-	-	-	-	-	-	-	V	0.55	
RE 630 G	-30 ... 200	0.02	III, FL	2.6	0.30 ¹	-	0.24 ¹	-	0.10 ¹	-	0.02 ¹	-	-	-	-	-	-	V	0.55	
RE 1050 G	-50 ... 200	0.02	III, FL	2.6	0.70 ¹	-	0.60 ¹	-	0.35 ¹	-	0.19 ¹	0.10 ¹	0.02 ¹	-	-	-	-	V	0.55	
RE 1225 G	-25 ... 200	0.02	III, FL	2.6	0.30 ¹	-	0.24 ¹	-	0.09 ¹	0.04 ¹	-	-	-	-	-	-	-	V	0.55	
RE 2025 G	-25 ... 200	0.02	III, FL	2.6	0.30 ¹	-	0.23 ¹	-	0.06 ¹	0.03 ¹	-	-	-	-	-	-	-	V	0.55	

¹Pump output step 2

Pump flow max. pressure L/min	Pump connection thread	Nipples Øe	Bath volume min. L	Bath volume max. L	Bath opening (W x D) mm	Bath depth mm	Usable depth mm	Height top of bath mm	Dimensions (W x D x H) mm	Weight kg	Power supply V; Hz	Loading max. kW	Part Number	Device type
15.0	N/A	13	5.0	7.5	165×177	160	140	450	235×500×605	29.0	230 V; 50 Hz & 220 V; 60 Hz	1.8	L000638*	RA 8
15.0	N/A	13	9.5	14.5	300×203	160	140	450	365×500×605	37.0	230 V; 50 Hz & 220 V; 60 Hz	1.8	L000639*	RA 12
15.0	N/A	13	14.0	22.0	350×277	160	140	450	415×605×605	43.0	230 V; 50 Hz & 220 V; 60 Hz	1.8	L000640*	RA 24
22.0	-	13	3.3	4.0	130×105	160	140	365	180×350×546	20.0	230 V; 50 Hz	2.2	L002815**	RE 415 S
22.0	-	13	3.3	4.0	130×105	160	140	374	180×396×555	22.0	230 V; 50 Hz	2.2	L001333**	RE 420 S
22.0	-	13	4.6	5.7	150×130	160	140	400	200×430×581	27.0	230 V; 50 Hz	2.3	L001335**	RE 630 S
22.0	-	13	8.0	10.0	200×200	160	140	443	280×440×624	34.0	230 V; 50 Hz	2.5	L001336**	RE 1050 S
22.0	-	13	9.3	12.0	200×200	200	180	443	250×435×624	31.0	230 V; 50 Hz	2.3	L001337**	RE 1225 S
22.0	-	13	14.0	20.0	300×350	160	140	443	350×570×624	38.0	230 V; 50 Hz	2.3	L001338**	RE 2025 S
22.0	M16×1	13	3.3	4.0	130×105	160	140	365	180×350×546	21.0	230 V; 50 Hz	2.8	L002816**	RE 415 G
22.0	M16×1	13	3.3	4.0	130×105	160	140	374	180×396×555	22.0	230 V; 50 Hz	2.8	L001339**	RE 420 G
22.0	M16×1	13	4.6	5.7	150×130	160	140	400	200×430×581	24.0	230 V; 50 Hz	2.9	L001341**	RE 630 G
22.0	M16×1	13	8.0	10.0	200×200	160	140	443	280×440×624	34.0	230 V; 50 Hz	3.1	L001342**	RE 1050 G
22.0	M16×1	13	9.3	12.0	200×200	200	180	443	250×435×624	31.0	230 V; 50 Hz	2.9	L001343**	RE 1225 G
22.0	M16×1	13	14.0	20.0	300×350	160	140	443	350×570×624	40.0	230 V; 50 Hz	2.9	L001344**	RE 2025 G

* Utilises traditional refrigerants (HFCs) in accordance with European legislation to control F-gases (EU) 573/2024.

Detailed information can be found on the respective product detail page of the order number at www.lauda.de

** Utilises natural refrigerants

LAUDA Cooling thermostats

Technical data according to DIN 12876 standard

Device type	Working temperature range °C	Temperature stability ±K	Safety fittings	Heater power max. kW	Cooling output kW													Pump type	Pump pressure max. bar	
					20 °C	10 °C	0 °C	-10 °C	-20 °C	-25 °C	-30 °C	-40 °C	-50 °C	-60 °C	-70 °C	-80 °C	-90 °C			-100 °C
LAUDA PRO / Page 94																				
RP 2040	-40 ... 200	0.01	III, FL	3.6	0.80 ³	0.80 ³	0.80 ³	0.60 ³	0.40 ²	-	0.19 ²	0.06 ²	-	-	-	-	-	-	V	-
RP 2045	-45 ... 200	0.01	III, FL	3.6	1.50 ³	1.43 ³	1.17 ³	0.84 ³	0.52 ²	-	0.28 ²	0.13 ²	-	-	-	-	-	-	V	-
RP 3035	-35 ... 200	0.01	III, FL	3.6	0.80 ³	0.80 ³	0.80 ³	0.58 ³	0.35 ²	-	0.16 ²	-	-	-	-	-	-	-	V	-
RP 1090	-90 ... 200	0.01	III, FL	3.6	0.80 ³	0.75 ³	0.72 ³	0.69 ³	0.66 ²	-	0.63 ²	0.60 ²	0.54 ²	0.37 ²	0.24 ²	0.11 ²	0.02 ²	-	V	-
RP 2090	-90 ... 200	0.01	III, FL	3.6	0.80 ³	0.71 ³	0.68 ³	0.65 ³	0.62 ²	-	0.61 ²	0.58 ²	0.52 ²	0.34 ²	0.18 ²	0.07 ²	0.01 ²	-	V	-
RP 10100	-100 ... 200	0.01	III, FL	3.6	0.40 ³	0.40 ³	0.40 ³	0.40 ³	0.40 ²	-	0.39 ²	0.37 ²	0.35 ²	0.32 ²	0.25 ²	0.17 ²	0.06 ²	0.01 ²	V	-
RP 2040 C	-40 ... 200	0.01	III, FL	3.6	0.80 ³	0.80 ³	0.80 ³	0.60 ³	0.40 ²	-	0.19 ²	0.06 ²	-	-	-	-	-	-	V	-
RP 2045 C	-45 ... 200	0.01	III, FL	3.6	1.50 ³	1.43 ³	1.17 ³	0.84 ³	0.52 ²	-	0.28 ²	0.13 ²	-	-	-	-	-	-	V	-
RP 3035 C	-35 ... 200	0.01	III, FL	3.6	0.80 ³	0.80 ³	0.80 ³	0.58 ³	0.35 ²	-	0.16 ²	-	-	-	-	-	-	-	V	-
RP 1090 C	-90 ... 200	0.01	III, FL	3.6	0.80 ³	0.75 ³	0.72 ³	0.69 ³	0.66 ²	-	0.63 ²	0.60 ²	0.54 ²	0.37 ²	0.24 ²	0.11 ²	0.02 ²	-	V	-
RP 2090 C	-90 ... 200	0.01	III, FL	3.6	0.80 ³	0.71 ³	0.68 ³	0.65 ³	0.62 ²	-	0.61 ²	0.58 ²	0.52 ²	0.34 ²	0.18 ²	0.07 ²	0.01 ²	-	V	-
RP 10100 C	-100 ... 200	0.01	III, FL	3.6	0.40 ³	0.40 ³	0.40 ³	0.40 ³	0.40 ²	-	0.39 ²	0.37 ²	0.35 ²	0.32 ²	0.25 ²	0.17 ²	0.06 ²	0.01 ²	V	-
LAUDA Proline Kryomats / Page 96																				
RP 4050 C	-50 ... 200	0.05	III, FL	3.5	5.00 ¹	-	3.00 ¹	-	1.60 ¹	-	1.00 ¹	0.50 ¹	0.25 ¹	-	-	-	-	-	V	0.5
RP 4050 CW	-50 ... 200	0.05	III, FL	3.5	6.00 ¹	-	3.50 ¹	-	1.80 ¹	-	1.10 ¹	0.60 ¹	0.25 ¹	-	-	-	-	-	V	0.5
RP 4090 C	-90 ... 200	0.05	III, FL	3.5	3.00 ¹	-	2.90 ¹	-	2.50 ¹	-	2.30 ¹	2.00 ¹	1.60 ¹	1.30 ¹	0.80 ¹	0.50 ¹	0.15 ¹	-	V	0.5
RP 4090 CW	-90 ... 200	0.05	III, FL	3.5	4.00 ¹	-	3.70 ¹	-	3.10 ¹	-	2.70 ¹	2.00 ¹	1.60 ¹	1.30 ¹	0.80 ¹	0.50 ¹	0.15 ¹	-	V	0.5

¹Pump output step 2 ²Pump output step 4 ³Pump output step 8 All device types with mark ›W‹ are water-cooled

Pump flow max. pressure L/min	Pump connection thread	Nipples Øe	Bath volume min. L	Bath volume max. L	Bath opening (W x D) mm	Bath depth mm	Usable depth mm	Height top of bath mm	Dimensions (W x D x H) mm	Weight kg	Power supply V; Hz	Loading max. kW	Part Number	Device type
-	N/A	-	12.5	21.0	300×290	200	180	568	400×565×680	51.0	230 V; 50 Hz	3.7	L000007**	RP 2040
-	N/A	-	12.5	21.0	300×290	200	180	568	400×565×680	59.0	230 V; 50 Hz	3.7	L000008**	RP 2045
-	N/A	-	17.5	29.5	340×375	200	180	568	440×600×680	54.0	230 V; 50 Hz	3.7	L000009**	RP 3035
-	N/A	-	6.5	10.5	240×150	200	180	618	440×600×730	85.0	230 V; 50 Hz	3.7	L000010**	RP 1090
-	N/A	-	12.5	21.0	300×290	200	180	618	500×600×730	91.0	230 V; 50 Hz	3.7	L000011**	RP 2090
-	N/A	-	6.5	10.5	240×150	200	180	618	500×600×730	86.0	230 V; 50 Hz	3.7	L000012**	RP 10100
-	N/A	-	12.5	21.0	300×290	200	180	568	400×565×730	52.0	230 V; 50 Hz	3.7	L000013**	RP 2040 C
-	N/A	-	12.5	21.0	300×290	200	180	568	400×565×730	59.0	230 V; 50 Hz	3.7	L000014**	RP 2045 C
-	N/A	-	17.5	29.5	340×375	200	180	568	440×600×730	55.0	230 V; 50 Hz	3.7	L000015**	RP 3035 C
-	N/A	-	6.5	10.5	240×150	200	180	618	440×600×780	86.0	230 V; 50 Hz	3.7	L000016**	RP 1090 C
-	N/A	-	12.5	21.0	300×290	200	180	618	500×600×780	89.0	230 V; 50 Hz	3.7	L000017**	RP 2090 C
-	N/A	-	6.5	10.5	240×150	200	180	618	500×600×780	86.0	230 V; 50 Hz	3.7	L000018**	RP 10100 C
19.0	M16×1	13	32.0	44.0	350×350	250	230	905	600×700×1216	129.0	400 V; 3/N/PE; 50 Hz	5.0	L001653*	RP 4050 C
19.0	M16×1	13	32.0	44.0	350×350	250	230	905	600×700×1216	124.0	400 V; 3/N/PE; 50 Hz	5.0	L001657*	RP 4050 CW
19.0	M16×1	13	32.0	44.0	350×350	250	230	905	600×700×1216	161.0	400 V; 3/N/PE; 50 Hz	7.0	L001655*	RP 4090 C
19.0	M16×1	13	32.0	44.0	350×350	250	230	905	600×700×1216	160.0	400 V; 3/N/PE; 50 Hz	7.0	L001659*	RP 4090 CW

* Utilises traditional refrigerants (HFCs) in accordance with European legislation to control F-gases (EU) 573/2024.

Detailed information can be found on the respective product detail page of the order number at www.lauda.de

** Utilises natural refrigerants

LAUDA Cooling thermostats

Power supply variants

Device type	Power supply V; Hz	Heater power max. kW	Loading max. kW	Plug code*	Part Number	Device type	Power supply V; Hz	Heater power max. kW	Loading max. kW	Plug code*	Part Number
LAUDA Alpha / Page 90											
RA 8	100 V; 50/60 Hz	1.0	1.3	14	L000653	RA 24	115 V; 60 Hz	1.2	1.5	14	L000652
RA 8	115 V; 60 Hz	1.2	1.5	14	L000650	RA 24	230 V; 50 Hz & 220 V; 60 Hz	1.4	1.8	17	L000649
RA 8	230 V; 50 Hz & 220 V; 60 Hz	1.4	1.8	17	L000638						
RA 12	115 V; 60 Hz	1.2	1.5	14	L000651						
RA 12	230 V; 50 Hz & 220 V; 60 Hz	1.4	1.8	17	L000639						
LAUDA ECO / Page 92											
RE 415 S	115 V; 60 Hz	1.3	1.4	14	L001433	RE 1050 S	100 V; 50/60 Hz	1.0	1.5	14	L001465
RE 415 S	220 V; 60 Hz	1.8	2.1	3	L001405	RE 1050 S	115 V; 60 Hz	1.3	1.4	14	L001437
RE 415 S	220 V; 60 Hz	1.8	2.1	2	L002073	RE 1050 S	220 V; 60 Hz	1.8	2.4	3	L001409
RE 415 G	115 V; 60 Hz	1.3	1.4	14	L001440	RE 1050 S	220 V; 60 Hz	1.8	2.4	2	L002077
RE 415 G	220 V; 60 Hz	2.4	2.6	3	L001412	RE 1050 G	100 V; 50/60 Hz	1.0	1.5	14	L001472
RE 415 G	220 V; 60 Hz	2.4	2.6	2	L002080	RE 1050 G	115 V; 60 Hz	1.3	1.4	14	L001444
RE 420 S	100 V; 50/60 Hz	1.0	1.2	14	L001462	RE 1050 G	220 V; 60 Hz	2.4	2.9	3	L001416
RE 420 S	115 V; 60 Hz	1.3	1.4	14	L001434	RE 1050 G	220 V; 60 Hz	1.8	2.4	2	L002084
RE 420 G	100 V; 50/60 Hz	1.0	1.2	14	L001469	RE 1225 S	100 V; 50/60 Hz	1.0	1.3	14	L001466
RE 420 G	115 V; 60 Hz	1.3	1.4	14	L001441	RE 1225 S	115 V; 60 Hz	1.3	1.4	14	L001438
RE 630 S	100 V; 50/60 Hz	1.0	1.3	14	L001464	RE 1225 S	220 V; 60 Hz	1.8	2.1	2	L002078
RE 630 S	115 V; 60 Hz	1.3	1.4	14	L001436	RE 1225 S	220 V; 60 Hz	1.8	2.1	3	L001410
RE 630 S	220 V; 60 Hz	1.8	2.1	3	L001408	RE 1225 G	100 V; 50/60 Hz	1.0	1.3	14	L001473
RE 630 S	220 V; 60 Hz	1.8	2.1	2	L002076	RE 1225 G	115 V; 60 Hz	1.3	1.4	14	L001445
RE 630 G	100 V; 50/60 Hz	1.0	1.3	14	L001471	RE 1225 G	220 V; 60 Hz	2.4	2.7	3	L001417
RE 630 G	115 V; 60 Hz	1.3	1.4	14	L001443	RE 2025 S	100 V; 50/60 Hz	1.0	1.3	14	L001467
RE 630 G	220 V; 60 Hz	2.4	2.7	2	L002083	RE 2025 S	115 V; 60 Hz	1.3	1.4	14	L001439
RE 630 G	220 V; 60 Hz	2.4	2.7	3	L001415	RE 2025 S	220 V; 60 Hz	1.8	2.1	2	L002079
						RE 2025 S	220 V; 60 Hz	1.8	2.1	3	L001411
						RE 2025 G	100 V; 50/60 Hz	1.0	1.3	14	L001474
						RE 2025 G	115 V; 60 Hz	1.3	1.4	14	L001446
						RE 2025 G	220 V; 60 Hz	2.4	2.7	3	L001418

*All data for the plug codes can be found on page 174

LAUDA Cooling thermostats

Power supply variants

Device type	Power supply V; Hz	Heater power max. kW	Loading max. kW	Plug code*	Part Number	Device type	Power supply V; Hz	Heater power max. kW	Loading max. kW	Plug code*	Part Number
LAUDA PRO / Page 94											
RP 2040	100 V; 50/60 Hz	1.3	1.6	32	L000538	RP 2045 C	200 V; 50/60 Hz	2.7	3.2	2	L000475
RP 2040	100 V; 50/60 Hz	1.3	1.5	14	L000530	RP 2045 C	200 V; 50/60 Hz	2.7	3.2	3	L000491
RP 2040	120 V; 60 Hz	1.9	1.9	32	L000458	RP 2045 C	200 V; 50/60 Hz	2.7	3.2	32	L000523
RP 2040	120 V; 60 Hz	1.9	1.9	4	L000450	RP 2045 C	200 V; 50/60 Hz	2.7	3.2	31	L000507
RP 2040	200 V; 50/60 Hz	2.7	3.2	31	L000498	RP 2045 C	208-220 V; 60 Hz	3.3	3.5	2	L000573
RP 2040	200 V; 50/60 Hz	2.7	3.2	32	L000514	RP 2045 C	208-220 V; 60 Hz	3.3	3.5	31	L000427
RP 2040	200 V; 50/60 Hz	2.7	3.2	3	L000482	RP 2045 C	208-220 V; 60 Hz	3.3	3.5	3	L000315
RP 2040	200 V; 50/60 Hz	2.7	3.2	2	L000466	RP 2045 C	208-220 V; 60 Hz	3.3	3.5	32	L000443
RP 2040	208-220 V; 60 Hz	3.3	3.5	32	L000434	RP 3035	100 V; 50/60 Hz	1.3	1.6	32	L000539
RP 2040	208-220 V; 60 Hz	3.3	3.5	2	L000564	RP 3035	100 V; 50/60 Hz	1.3	1.5	14	L000531
RP 2040	208-220 V; 60 Hz	3.3	3.5	31	L000418	RP 3035	120 V; 60 Hz	1.9	1.9	32	L000459
RP 2040	208-220 V; 60 Hz	3.3	3.5	3	L000306	RP 3035	120 V; 60 Hz	1.9	1.9	4	L000451
RP 2040 C	100 V; 50/60 Hz	1.3	1.5	14	L000534	RP 3035	200 V; 50/60 Hz	2.7	3.2	31	L000500
RP 2040 C	100 V; 50/60 Hz	1.3	1.6	32	L000542	RP 3035	200 V; 50/60 Hz	2.7	3.2	32	L000516
RP 2040 C	120 V; 60 Hz	1.9	1.9	32	L000462	RP 3035	200 V; 50/60 Hz	2.7	3.2	2	L000468
RP 2040 C	120 V; 60 Hz	1.9	1.9	4	L000454	RP 3035	200 V; 50/60 Hz	2.7	3.2	3	L000484
RP 2040 C	200 V; 50/60 Hz	2.7	3.2	3	L000490	RP 3035	208-220 V; 60 Hz	3.3	3.5	31	L000420
RP 2040 C	200 V; 50/60 Hz	2.7	3.2	31	L000506	RP 3035	208-220 V; 60 Hz	3.3	3.5	3	L000308
RP 2040 C	200 V; 50/60 Hz	2.7	3.2	32	L000522	RP 3035	208-220 V; 60 Hz	3.3	3.5	2	L000566
RP 2040 C	200 V; 50/60 Hz	2.7	3.2	2	L000474	RP 3035	208-220 V; 60 Hz	3.3	3.5	32	L000436
RP 2040 C	208-220 V; 60 Hz	3.3	3.5	3	L000314	RP 3035 C	100 V; 50/60 Hz	1.3	1.5	14	L000535
RP 2040 C	208-220 V; 60 Hz	3.3	3.5	32	L000442	RP 3035 C	100 V; 50/60 Hz	1.3	1.6	32	L000543
RP 2040 C	208-220 V; 60 Hz	3.3	3.5	31	L000426	RP 3035 C	120 V; 60 Hz	1.9	1.9	4	L000455
RP 2040 C	208-220 V; 60 Hz	3.3	3.5	2	L000572	RP 3035 C	120 V; 60 Hz	1.9	1.9	32	L000463
RP 2045	200 V; 50/60 Hz	2.7	3.2	31	L000499	RP 3035 C	200 V; 50/60 Hz	2.7	3.2	2	L000476
RP 2045	200 V; 50/60 Hz	2.7	3.2	3	L000483	RP 3035 C	200 V; 50/60 Hz	2.7	3.2	32	L000524
RP 2045	200 V; 50/60 Hz	2.7	3.2	2	L000467	RP 3035 C	200 V; 50/60 Hz	2.7	3.2	31	L000508
RP 2045	200 V; 50/60 Hz	2.7	3.2	32	L000515	RP 3035 C	200 V; 50/60 Hz	2.7	3.2	3	L000492
RP 2045	208-220 V; 60 Hz	3.3	3.5	2	L000565	RP 3035 C	208-220 V; 60 Hz	3.3	3.5	31	L000428
RP 2045	208-220 V; 60 Hz	3.3	3.5	31	L000419	RP 3035 C	208-220 V; 60 Hz	3.3	3.5	3	L000316
RP 2045	208-220 V; 60 Hz	3.3	3.5	32	L000435	RP 3035 C	208-220 V; 60 Hz	3.3	3.5	2	L000574
RP 2045	208-220 V; 60 Hz	3.3	3.5	3	L000307	RP 3035 C	208-220 V; 60 Hz	3.3	3.5	32	L000444

Device type	Power supply V; Hz	Heater power max. kW	Loading max. kW	Plug code*	Part Number	Device type	Power supply V; Hz	Heater power max. kW	Loading max. kW	Plug code*	Part Number
LAUDA PRO / Page 94											
RP 1090	200 V; 50/60 Hz	2.7	3.2	3	L000485	RP 2090 C	200 V; 50/60 Hz	2.7	3.2	2	L000478
RP 1090	200 V; 50/60 Hz	2.7	3.2	32	L000517	RP 2090 C	200 V; 50/60 Hz	2.7	3.2	3	L000494
RP 1090	200 V; 50/60 Hz	2.7	3.2	2	L000469	RP 2090 C	200 V; 50/60 Hz	2.7	3.2	32	L000526
RP 1090	200 V; 50/60 Hz	2.7	3.2	31	L000501	RP 2090 C	200 V; 50/60 Hz	2.7	3.2	31	L000510
RP 1090	208-220 V; 60 Hz	3.3	3.5	32	L000437	RP 2090 C	208-220 V; 60 Hz	3.3	3.5	3	L000318
RP 1090	208-220 V; 60 Hz	3.3	3.5	3	L000309	RP 2090 C	208-220 V; 60 Hz	3.3	3.5	32	L000446
RP 1090	208-220 V; 60 Hz	3.3	3.5	2	L000567	RP 2090 C	208-220 V; 60 Hz	3.3	3.5	31	L000430
RP 1090	208-220 V; 60 Hz	3.3	3.5	31	L000421	RP 2090 C	208-220 V; 60 Hz	3.3	3.5	2	L000576
RP 1090 C	200 V; 50/60 Hz	2.7	3.2	32	L000525	RP 10100	200 V; 50/60 Hz	2.7	3.2	32	L000519
RP 1090 C	200 V; 50/60 Hz	2.7	3.2	2	L000477	RP 10100	200 V; 50/60 Hz	2.7	3.2	31	L000503
RP 1090 C	200 V; 50/60 Hz	2.7	3.2	31	L000509	RP 10100	200 V; 50/60 Hz	2.7	3.2	2	L000471
RP 1090 C	200 V; 50/60 Hz	2.7	3.2	3	L000493	RP 10100	200 V; 50/60 Hz	2.7	3.2	3	L000487
RP 1090 C	208-220 V; 60 Hz	3.3	3.5	31	L000429	RP 10100	208-220 V; 60 Hz	3.3	3.5	32	L000439
RP 1090 C	208-220 V; 60 Hz	3.3	3.5	2	L000575	RP 10100	208-220 V; 60 Hz	3.3	3.5	31	L000423
RP 1090 C	208-220 V; 60 Hz	3.3	3.5	32	L000445	RP 10100	208-220 V; 60 Hz	3.3	3.5	2	L000569
RP 1090 C	208-220 V; 60 Hz	3.3	3.5	3	L000317	RP 10100	208-220 V; 60 Hz	3.3	3.5	3	L000311
RP 2090	200 V; 50/60 Hz	2.7	3.2	2	L000470	RP 10100 C	200 V; 50/60 Hz	2.7	3.2	32	L000527
RP 2090	200 V; 50/60 Hz	2.7	3.2	32	L000518	RP 10100 C	200 V; 50/60 Hz	2.7	3.2	31	L000511
RP 2090	200 V; 50/60 Hz	2.7	3.2	31	L000502	RP 10100 C	200 V; 50/60 Hz	2.7	3.2	3	L000495
RP 2090	200 V; 50/60 Hz	2.7	3.2	3	L000486	RP 10100 C	200 V; 50/60 Hz	2.7	3.2	2	L000479
RP 2090	208-220 V; 60 Hz	3.3	3.5	32	L000438	RP 10100 C	208-220 V; 60 Hz	3.3	3.5	3	L000319
RP 2090	208-220 V; 60 Hz	3.3	3.5	2	L000568	RP 10100 C	208-220 V; 60 Hz	3.3	3.5	31	L000431
RP 2090	208-220 V; 60 Hz	3.3	3.5	3	L000310	RP 10100 C	208-220 V; 60 Hz	3.3	3.5	32	L000447
RP 2090	208-220 V; 60 Hz	3.3	3.5	31	L000422	RP 10100 C	208-220 V; 60 Hz	3.3	3.5	2	L000577
LAUDA Proline Kryomats / Page 96											
RP 4050 C	200 V; 3/PE; 50/60 Hz	2.8	5.0	31	L001701	RP 4090 C	200 V; 3/PE; 50/60 Hz	2.8	7.0	31	L001703
RP 4050 C	208 V; 3/PE; 60 Hz	3.0	5.0	31	L001677	RP 4090 C	208 V; 3/PE; 60 Hz	3.0	7.0	31	L001679
RP 4050 CW	200 V; 3/PE; 50/60 Hz	2.8	5.0	31	L001705	RP 4090 CW	200 V; 3/PE; 50/60 Hz	2.8	7.0	31	L001707
RP 4050 CW	208 V; 3/PE; 60 Hz	3.0	5.0	31	L001681	RP 4090 CW	208 V; 3/PE; 60 Hz	3.0	7.0	31	L001683

*All data for the plug codes can be found on page 174

All device types with mark › W‹ are water-cooled

LAUDA Cooling thermostats

More characteristics

LAUDA Alpha / Page 90

PUMP CHARACTERISTIC Heat transfer liquid: Water

Pressure bar

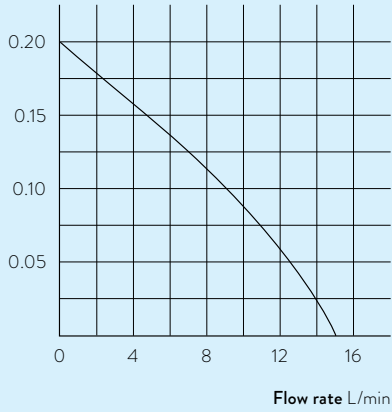

LAUDA ECO / Page 92

COOLING PERFORMANCE According to DIN 12876, Heat transfer liquid: Water

Bath temperature °C

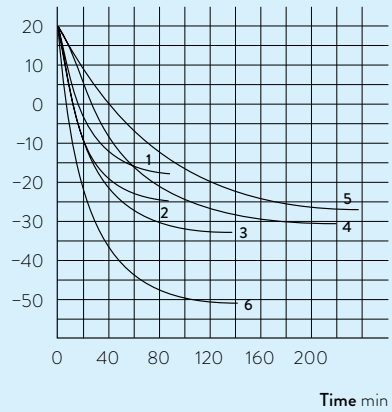

- 1 RE 415 S
- 2 RE 420 S
- 3 RE 630 S
- 4 RE 1225 S
- 5 RE 2025 S
- 6 RE 1050 S

PUMP CHARACTERISTIC Heat transfer liquid: Water

Pressure bar

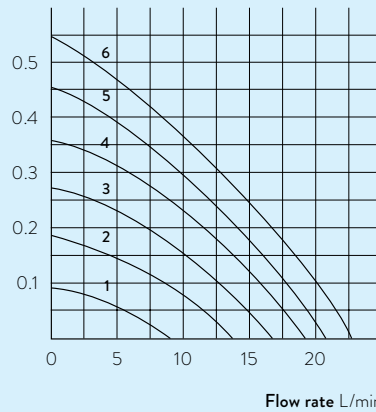

- 1 Step 1
- 2 Step 2
- 3 Step 3
- 4 Step 4
- 5 Step 5
- 6 Step 6

LAUDA Proline Kryomats / Page 96

COOLING PERFORMANCE According to DIN 12876, Heat transfer liquid: Water

Bath temperature °C

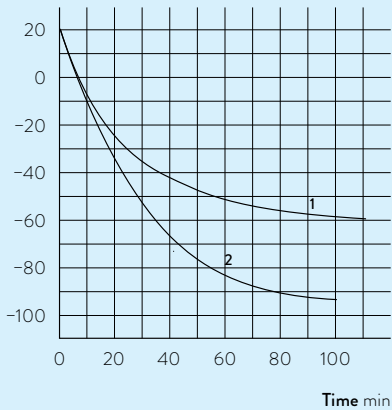

- 1 RP 4050 CW
- 2 RP 4090 CW

